



Model # Shown: 01650

OVERVIEW

Shipped ready to assemble, these desks have a heavy-duty work surface that won't sag under heavy books or equipment. The Silhouette Desk is great for rows, pairs, or groupings for collaborative learning.

MATERIALS

The work surface consists of a 45 lb density particle board core with a .030" high pressure laminated surface and a .020" melamine backer sheet. The edge of the work surface features 3/8" bumper edge molding that is fastened every 6 to 8 inches to assure a long lasting fit. The frame is attached to the pre-drilled holes in the top with (6) #10 screws through a 1" x 1.75" 18-gauge steel channel. The mounting channel is welded to a 1" x 2" rectangular 16-gauge steel tube leg. The leg inserts are 1" x 1.75" 16-gauge steel tube and are fixed in height at 29.5".

The legs are tied together for added strength with a 1" x 2" 16-gauge steel tube stretcher bar and (4) bolts. Legs have 1" leveling glides. Book Box is optional (Model 17190), all welded 22-gauge steel construction that has a curled hem on the front opening. Book box comes in a black powdercoat finish, or Platinum is special order only. *Book box sold separately.

TOP AND EDGE OPTIONS

1 1/4" TOP W/ BUMPER T-MOLD
NO LETTER TO FOLLOW MODEL NO.

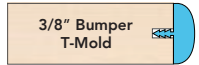

1 1/4" TOP W/ 4MM T-MOLD
D

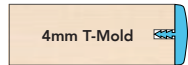

3/4" TOP W/ BULLET T-MOLD
V

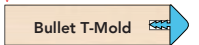

3/4" TOP W/ 4MM T-MOLD
C

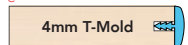

1 1/4" TOP W/ 3MM - 90° CORNERS
H

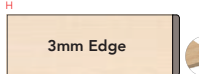

1 1/4" TOP W/ 3MM - ROUND CORNERS
F

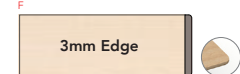

3/4" TOP W/ 3MM - 90° CORNERS
E

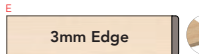

3/4" TOP W/ 3MM - ROUND CORNERS
G

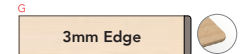

DIMENSIONS

Model	Description	D"	W"	H"	WT
01649	Single-Student 20x27 Fixed Height Desk w/glides	20	27	29.5	40
Optional Accessories					
17190	Steel Bookbox	15	20	4	8
17018	Technology Basket	13	10	2	1
17200	Wire Bookbasket	15	18	3.5	5
30933	SW (Standard Width) 3" SW Tote w/housing	17.25	12.75	5	3.1
30935	EW (Extra Wide) 3" EW Tote w/housing	17.25	19	4.25	7.3
17576	3" Dual-Wheel Caster Pack (Set of 4, 4 locking)-Black		3 dia.		5
17577	3" Dual-Wheel Caster Pack (Set of 4, 4 locking)-Colors		3 dia.		5

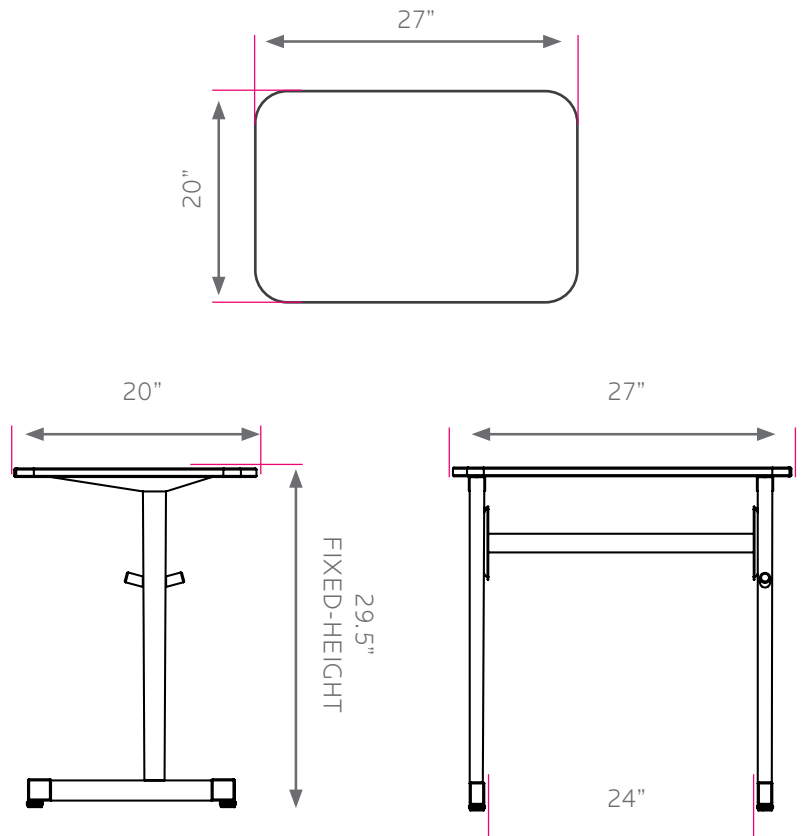

STANDARD LAMINATE OPTIONS

Want to specify a different laminate?

No problem. If you have 20 or more tops of the same color -60 or -38 there is no upcharge. Have 20 or less? We can quote for you with the Wilsonart code and - finish style. We can specify other laminates - call to inquire and get a quote.

SURFACE LAMINATE OPTIONS WITH MATCHING 3MM EDGE BAND



ASIAN NIGHT
7949-60



BOARDWALK OAK
7983-60



BUKA BARK
7982-60



CLASSIC LINEN
4943-60



FLAX LINEN
4990-60

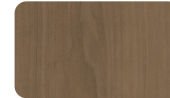

FRENCH PEAR
8220-60



FUSION MAPLE
7909-60



GREY NEBULA
4622-60



HIGH RISE
4996-60



MISSION MAPLE
7990-60



NEW AGE OAK
7938-60



NORTH SEA GRAY
D90-60



PALISADES OAK
7987-60

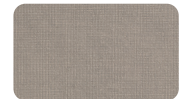

PEWTER MESH
4878-60



WILD CHERRY
7054-60

All 15 of the standard laminates are -60 finish, if you need to match a laminate from a previous year, please let us know on your order (example Pewter Mesh 4878-38, our standard is -60).

When the WilsonArt Laminate code includes a "Y", "K", "-12", "-78", "Aeon" etc, these are special laminates with an upcharge, even when it contains -38 or -60.

STANDARD EDGE COLOR OPTIONS



APPLE



BLACK



CERULEAN



CHARCOAL



NAVY



PERSIAN BLUE



PLATINUM

LEG COLOR OPTIONS



BLACK



PLATINUM

EDGE COLOR OPTIONS WITH ADDITIONAL LEAD TIME



BLUEBERRY



BURGUNDY



CHAMPAGNE



FOREST GREEN



ORANGE



PURPLE



RED



YELLOW